



# SME1900-17

Broadband Surface Mount Mixer

## Product Features

- RF 1600 to 2400 MHz
- LO 1400 to 2390 MHz
- IF 10 to 250 MHz
- High 3IIP: +29 dBm (Typical)
- LO Drive: +17 dBm
- No Internal Solder Connections

## Functional Diagram

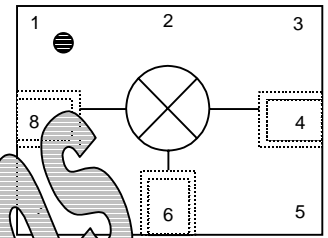

Function	Pin No.
Ground	1-3
RF	4
Ground	5
IF	6
Ground	7
LO	8

## Specifications

Parameters	Unit	Guaranteed	
		+25°C	-40° to +70°C
SSB Conversion Loss (Max)	dB		
RF = 1600-2000 MHz, LO = 1400-2390 MHz		7.4	8.9
RF = 1600-2400 MHz, LO = 1400-2390 MHz		8.4	9.9
Port-to-Port Isolation (Min)	dB		
L-R = 1600-2000 MHz		26	19
L-R = 1600-2390 MHz		22	16
L-I = 1600-2000 MHz		30	24
L-I = 1600-2390 MHz		23	17
R-I	dB	25	
3 <sup>rd</sup> Order Intercept Point (Min)	dBm	29	
VSWR	dB		
R-Port = 1600-2000 MHz		1.7:1	
R-Port = 1600-2390 MHz		1.8:1	
L-Port = 1600 MHz		2.4:1	
L-Port = 2000 MHz		1.5:1	
I-Port		1.8:1	
1 dB Conversion Compression (Typ)	dBm	+14	

1. Measured in a 50-ohm system with nominal LO drive of +17 dBm, low side LO, and downconverter application only, unless otherwise specified.  
 2. Measured at RF = 1850-1990 MHz, LO = 1610-1750 MHz, IF = 240 MHz, unless otherwise specified.

## Absolute Maximum Ratings

Parameters	Rating
Operating Temperature	-40 to +70 °C
Storage Temperature	-65 to +100 °C
RF Input Power	+23 dBm at +25°C

## Ordering Information

Part No.	Description
SME1900-17	Mixer (Available in tape and reel)
SME1900-17-PCB	Fully Assembled App. Ckt.

## Performance Charts

### IIP3 vs. Frequency

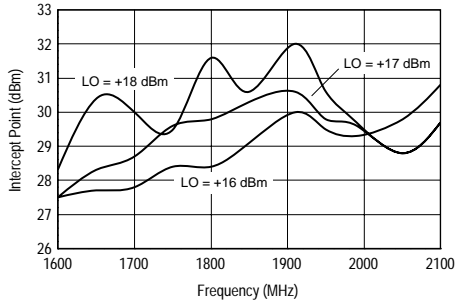

### IIP3 vs. Frequency

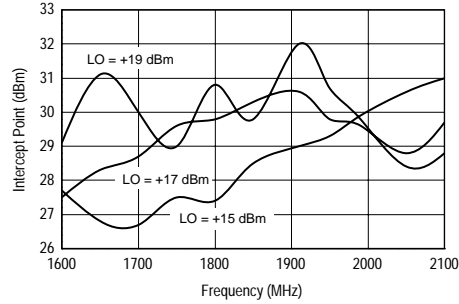

### Conversion Loss vs. RF Frequency

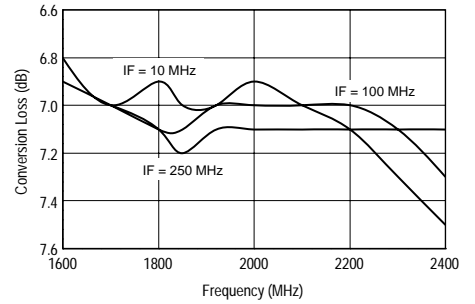

### Conversion Loss vs. RF Power

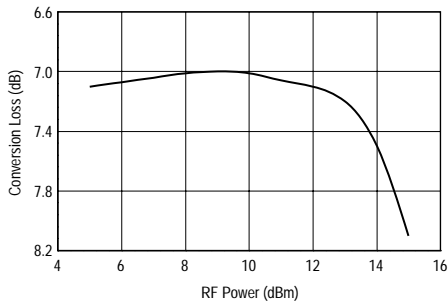

### Conversion Loss vs. LO Power

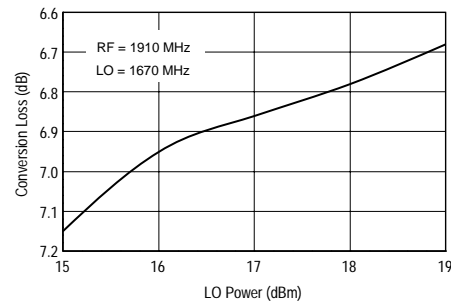

### Conversion Loss vs. Temperature

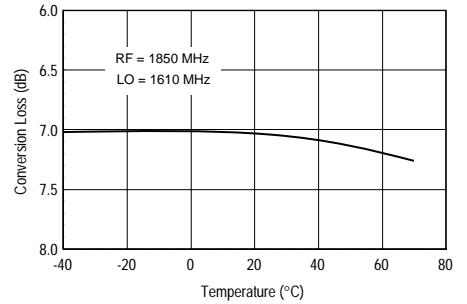

### VSWR vs. Frequency

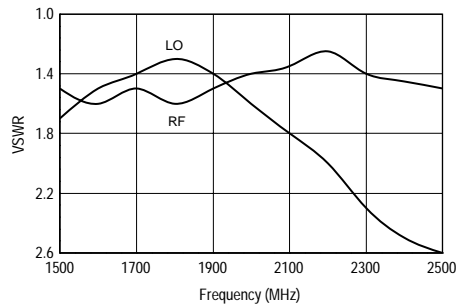

### IF VSWR vs. Frequency

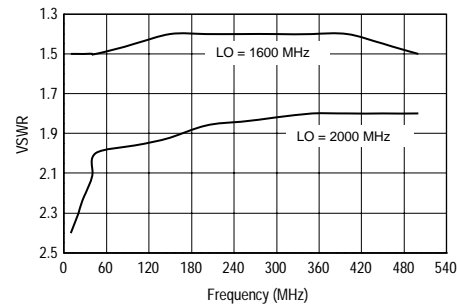

### Isolation vs. Frequency

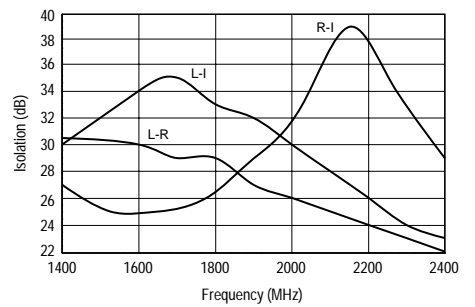



# SME1900-17

Low Cost Surface Mount Mixer

The Communications Edge™

## Single-Tone IM Products

Harmonics of fLO

	0	1	2	3	4	5
0		21	27	36	36	29
1	26	0	29	24	24	38
2	62	56	64	58	61	65
3	>80	>80	>80	>80	>80	79
4	>80	>80	>80	>80	>80	>80
5	>80	>80	>80	>80	>80	>80

LO Mult	RF Mult	LO MHz	RF MHz	IM Prod MHz	IM Prod dB
0	1	2150	2200	2200	26
0	2	2150	2200	4400	62
0	3	2150	2200	6600	81
0	4	2150	2200	8800	95
0	5	2150	2200	11000	95
1	0	2150	2200	2150	21
-1	1	2150	2200	50	0
1	-2	2150	1100	50	56
1	-3	2150	734	50	57
1	-4	2150	550	50	95
-1	5	2150	440	50	57
2	0	2150	2200	4300	26
2	-1	2150	2200	50	29
-2	1	2150	1100	50	64
-2	2	2150	734	50	79
-2	3	2150	550	50	95
-2	4	2150	380	50	95
-2	5	2150	270	50	95
3	0	2150	2200	6450	36
-3	1	2150	6500	50	24
-3	2	2150	3250	50	58
-3	3	2150	2167	50	83
-3	4	2150	1625	50	94
-3	5	2150	1300	50	94
4	0	2150	2200	8600	36
-4	1	2150	8650	50	24
-4	2	2150	4325	50	61
-4	3	2150	2884	50	81
-4	4	2150	2163	50	95
-4	5	2150	1730	50	95
5	0	2150	2200	10750	29
-5	1	2150	10800	50	38
-5	2	2150	5400	50	65
-5	3	2150	3600	50	79
-5	4	2150	2700	50	93
-5	5	2150	2160	50	95

Motor for New Designs

Test Conditions RF at -10 dBm; LO at +17 dBm  
 RF harmonics and intermodulation products are referenced  
 fRF = 2150 MHz and fRF = 2200 MHz  
 LO harmonics are referenced to the LO drive signal.



# SME1900-17

Low Cost Surface Mount Mixer

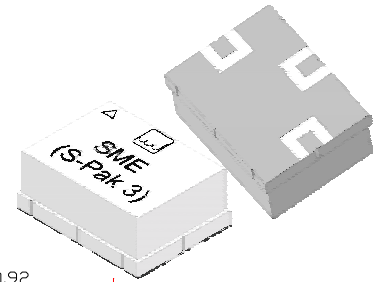

## OUTLINE DRAWING

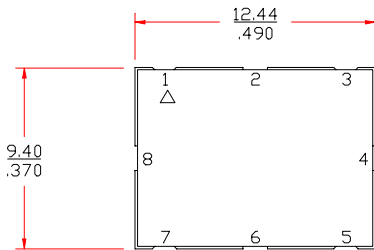

TOP VIEW

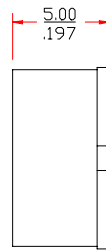

mm  
inch

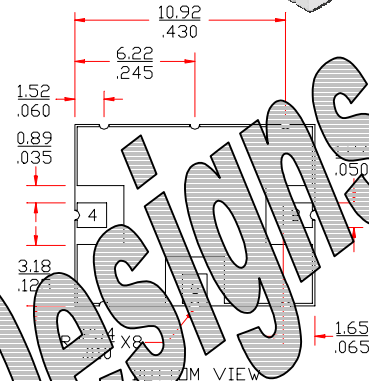

DIM VIEW

## LAND PATTERN

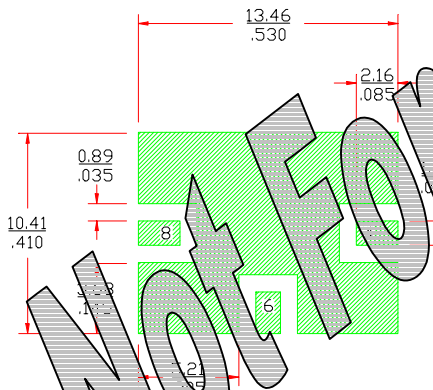

TOP VIEW

## GROUNDING CONFIGURATION

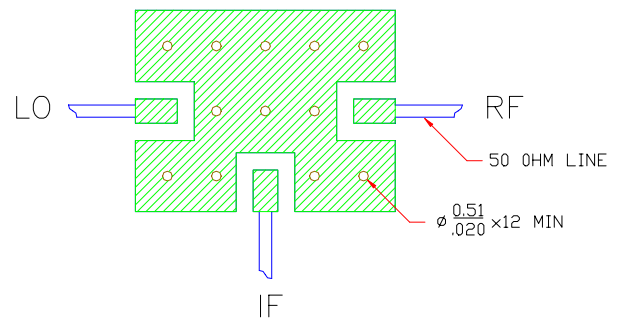

FUNCTION	PIN NO.
GROUND	1-3
RF	4
GROUND	5
IF	6
GROUND	7
LD	8

- Notes:
1. Ground vias are critical for thermal and RF grounding considerations.
  2. A minimum of 12 ground vias are required.
  3. If your PCB design rules allow, ground vias should be placed under the land pattern for better RF and thermal performance. Otherwise ground vias should be placed as close to land pattern as possible.
  4. Trace width depends on PC board.